

S 型单级双吸

清水离心泵

S XING DAN JI SHUANG XI QING SHUI LI XIN BEN



上海民泉泵业有限公司



上海民泉泵业有限公司

地址：上海市交通西路48号 电话：021-36523279 网址：www.minquan021.com

概 述

S型单级双吸离心泵是新型节能卧式中开泵，供输送清水或物理化学性质类似于水的其他液体，根据用户需求，通过改变泵结构及材质可用于输送多泥砂水或各类腐蚀性液体，该系列泵适用于工厂、矿山、城市给排水、电站、农田排灌及各种水利工程。

型 号 意 义

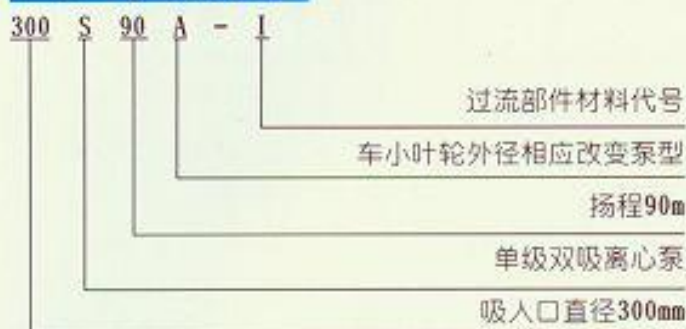

过流部件主要材料代号表

材料代号	材料牌号
I	HT-4
II	1Cr18Ni9Ti
III	1Cr18Ni12Mo2Ti
未注	HT200

结 构 说 明

本型泵的吸入口与吐出口均在水泵轴心线的下方，与轴线垂直或水平方向。检修时无需拆卸进出口水管及电机。从传动方向看去，水泵为顺时针方向旋转（根据用户需要亦可改为逆时针方向旋转）。

泵主要零件有：泵体、泵盖、叶轮、轴、双吸密封环、轴套等。

泵体与泵盖构成叶轮的工作室。在进出水法兰上，制有安装真空表和压力表的管螺孔。进出水法兰的下部，制有放水的管螺孔。

经过静平衡校验的叶轮，用轴套和两边的轴套螺母固定在轴上，其轴向位置可通过轴套螺母进行调整。

泵轴由两个单列向心球轴承支承。轴承装在轴承体内、安装在泵体两端，用黄油润滑。

双吸密封环用以减少水泵压力室的水漏回吸水室。

泵通过弹性联轴器由电动机直接传动，必要时亦可用内燃机传动。

轴封为软填料密封（根据用户需要可采用机械密封结构）。

结 构 图

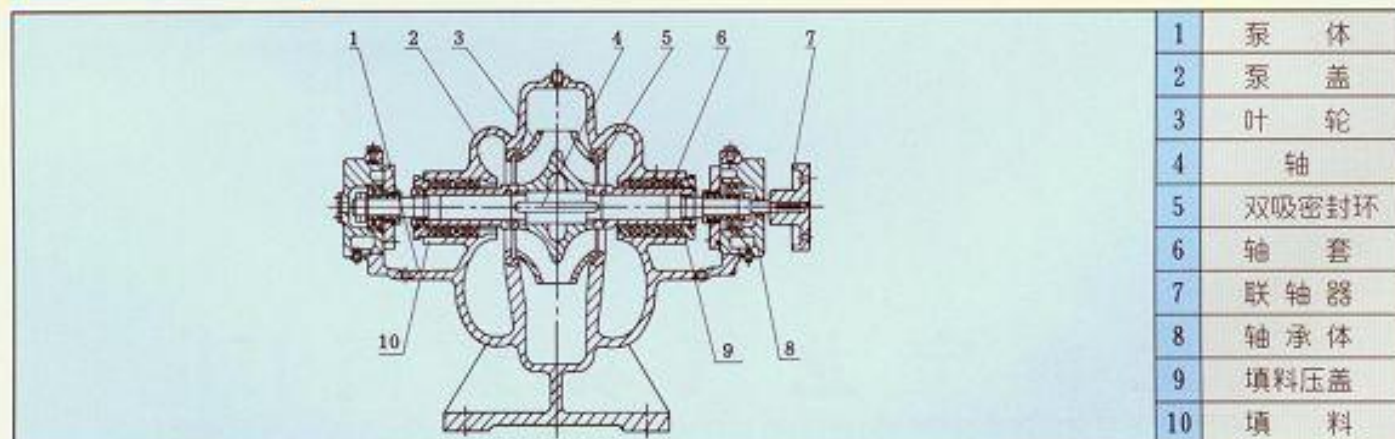

安 装

1. 检查水泵和电动机应无损坏。

2. 水泵的安装高度，加上吸入管路的水力损失，及其速度能，不得大于样本规定的允许吸上真空高度值。基础尺寸应符合泵机组的安装尺寸。

3. 安装顺序：

① 将水泵放在埋有地脚螺栓的混凝土基础上，用调整其间的楔形垫块的方法校正水平，并适当拧紧地脚螺栓，以防走动。

② 在基础与泵地脚之间灌注混凝土。

③ 待混凝土干固后，拧紧地脚螺栓，并重新检查水泵的水平度。

④ 校正电动机轴与泵轴的同心度。使两轴成一直线，在两轴外圆上的同轴度允差为0.1mm，端面间隙沿圆周的不均匀度允差0.3mm(在联接进水管路及试运行后在分别校正一遍，仍应符合上述要求)。

⑤ 在检查电动机转向与水泵转向一致后，装上联轴器及联接柱销。

4. 进水管路应另设支架支撑，不得借泵体支承。

5. 水泵与管路之间的结合面，应保证良好的气密性，尤其是进水管路，应严格保证不漏气，并且在装置上应无窝存空气的可能。

6. 如水泵安装在进水水位以上时，为了灌泵起动，一般可装底阀。也可采用真空引水的方法。

7. 水泵与出水管路之间一般需装闸阀和止回阀(扬程小于20m的可不用)，止回阀装在闸阀后面。

以上所述的安装方法是指不配带公共底座的水泵机组。

安装配带公共底座的泵，用调整底座与混凝土基础之间的楔形垫块来校正机组的水平，然后在其间灌注混凝土。其安装原则与要求，和不配带公共底座的机组相同。

起 动、停 止 和 运 行

1. 起动与停止：

① 起动前，转动泵的转子，应该轻滑均匀。

② 关闭出水闸阀，向泵内注水(如无底阀则采用真空泵抽空引水)，要保证泵内充满水，无空气窝存。

③ 如果泵上装有真空表或压力表，要关闭其与泵相联接的旋塞再起动电机，待转速正常后再打开；然后逐渐打开出水闸阀，如流量过大，可适当地关小闸阀进行调节；反之流量过小时，将闸阀开大。

④ 均匀地拧紧填料压盖上的压紧螺母，使液体成滴状漏出，同时注意填料腔处的温升。

⑤ 当停止水泵运转时，要关闭真空表及压力表的旋塞和出水管路上的闸阀，然后关闭电动机电源，如所处环境温度较低时，则应将泵体下端的四方螺塞打开，放掉余水，以免泵体冻裂。

⑥ 长期停止使用时，应拆开水泵将零件上的水擦干，在加工表面涂上防锈油保管好。

2. 运转：

① 水泵轴承最高温度不得超过75℃。

② 润滑轴承用的钙基黄油的数量以占轴承体空间的1/3~1/2为宜。

③ 填料磨损时可适当压紧填料压盖，若磨损过多应加以更换。

④ 定期检查联轴器部件，注意电机轴承温升。

⑤ 运转过程中，如发现噪声或其他不正常声响时，应立即停车，检查其原因，加以消除。

⑥ 不得任意提高水泵的转速，但可以降低转速使用，如本型泵额定转速为n，流量为Q，扬程为H，轴功率为N，降低转速为n₁，降速后流量，扬程，轴功率分别为Q₁、H₁和N₁，其相互关系，可用下列公式进行换算。

$$Q_1 = (n_1/n)Q \quad H_1 = (n_1/n)^2 H \quad N_1 = (n_1/n)^3 N$$

装配与拆卸

1. 装配转子部件：依次将叶轮、轴套、轴套螺母、填料套、填料环、填料压盖、挡水圈、轴承部件装在泵轴上，并套上双吸密封环，然后装上联轴器。

2. 将转子部件装在泵体上，调整叶轮的轴向位置到双吸密封环的中间加以固定，将轴承体压盖同固定螺钉紧固。

3. 装上填料，放好中开面纸垫，盖上泵盖打紧螺尾柱销后，拧紧泵盖螺母，最后装上填料压盖。但不要将填料压得太紧，填料过紧会使轴套发热，耗费功率较大，也不要压得太松，过松会使液体渗漏大，水泵效率降低。

装配完成后，用手转动泵轴，没有擦碰现象，转动比较轻滑均匀即可，拆卸可按上述装配顺序相反进行。

故障及其消除方法

故障	原因	消除方法
1. 泵不吸水，压力表及真空表指针剧烈跳动。	①注入水不够； ②管路或仪表漏气。	①再往泵内注水； ②拧紧堵塞漏气处。
2. 泵不吸水，真空表显示高度真空。	①底阀没打开或已淤塞； ②吸水管路阻力太大； ③吸水高度太高。	①校正或更换底阀； ②清洗或更换吸水管路； ③降低吸水高度。
3. 泵不出水，压力表显示有压力。	①出水管路阻力太大； ②旋转方向不对； ③叶轮堵塞； ④转速不够。	①检查或缩短出水管路； ②纠正电动机旋转方向； ③清洗叶轮； ④提高转速。
4. 流量不足或扬程太低。	①叶轮或进出水管路阻塞； ②双吸密封环磨损过多，或叶轮损坏； ③转速低于规定值。	①清洗叶轮或管路； ②更换损坏的零件； ③调正至额定转速。
5. 泵消耗的功率过大。	①填料压得太紧； ②叶轮与双吸密封环摩擦； ③流量过大。	①拧松填料压盖； ②检查原因，消除机械摩擦； ③调节出水闸阀，使之在规定时间内运转。
6. 泵内部声音反常，泵不上水。	①吸水管阻力太大；或吸水高度过高； ②吸水处有空气吸入； ③所输送液体温度过高； ④流量过大而发生汽蚀现象。	①清理进水管及底阀；降低吸水高度； ②检查底阀；降低吸水高度，堵塞漏气处； ③调节液体温度； ④调节出水闸阀，使之在规定时间内运转。
7. 泵不正常振动。	①泵发生汽蚀； ②叶轮不平衡； ③泵轴与电机轴不同心； ④地脚螺栓松动。	①调节出水闸阀，使之在规定时间内运转； ②叶轮校正静平衡； ③校正泵轴与电机轴的同轴度； ④拧紧地脚螺栓。
8. 轴承过热。	①轴承内没有油； ②泵轴与电机轴不在同一中心线上。	①检查并清洗轴承体，加润滑油； ②校正两轴的同轴度使在同一中心线上。

DAN JI SHUANG XI QING SHUI LI XIN BENG

性能表

型号	流量 Q (m ³ /h)	扬程 H (m)	转速 n (r/min)	功率p (kw)		效率 η (%)	汽蚀余量 (NPSH) r (m)	重量 (kg)		
				轴功率	电机功率					
150S78	126	82	2950	40	55	70	3.7	140		
	160	78		45		75.5				
	198	70		52		72				
150S78A	112	67		30.1	45	68			3.9	130
	144	62		33.4		72.6				
	180	55		38.5		70				
150S50	130	52		25.2	37	73	5.3	260		
	160	50		27.3		80.4				
	220	40		31.1		77				
150S50A	112	44		18.6	30	72			5.8	230
	144	40		20.0		75.5				
	180	35		24.5		70				
150S50B	108	38		17.2	22	65	6	180		
	133	36		18.0		72.5				
	160	32		19.4		72				
200S95	183	103		83.1	132	62			5.3	260
	280	95		91.4		79.2				
	324	87		102.4		75				
200S95A	180	92		67.3	110	67	5.8	230		
	270	85		83.3		75				
	324	78		94.3		73				
200S95B	180	82		64.8	90	62			6	180
	260	75		73.8		72				
	306	68		80.9		70				
200S63	216	69	54.8	75	74	3.1	485			
	280	63	58.3		82.7					
	351	53	66.7		76					
200S63A	180	54	37.8	55	70			3.2	380	
	270	46	45.1		75					
	324	37	46.6		70					
200S42	216	48	34.8	45	81	3.5	365			
	280	42	38.1		84.2					
	324	35	40.2		81					
200S42A	198	43	30.5	37	76			3.8	320	
	270	36	33.1		80					
	310	31	34.4		76					
250S65	360	71	92.8	132	75	4.2	840			
	485	65	109.2		78.6					
	612	58	130.6		74					
250S65A	342	61	77	90	74			4.4	810	
	420	48	88.5		77.7					
	540	50	98		75					
250S39	360	42	54.2	75	76	4.4	810			
	485	39	61.5		83.6					
	612	32	67.5		79					
250S39A	324	35	41.7	55	74			4.4	810	
	468	30	48.4		79					
	576	25	50.9		77					
250S24	360	27	33.1	45	80	4.4	810			
	485	24	36.9		85.8					
	576	19	36.4		82					
250S24A	324	22	25.6	37	80			4.4	810	
	414	20	27.2		83.3					
	482	17	27.9		80					
250S14	360	16	19.6	30	80	4.4	810			
	485	14	21.5		85.8					
	576	11	22.1		78					
250S14A	320	13	14.5	18.5	78			4.4	810	
	432	11	15.2		82.7					
	504	8	14.6		75					
300S90	590	93	202	320	74	4.4	810			
	790	90	243		79.6					
	936	82	279		75					
300S90A	576	86	190	280	71			4.4	810	
	756	78	216.4		74.2					
	918	70	247		71					
300S90B	540	72	150	220	70	4.4	810			
	720	67	180		73					
	900	57	200		70					
300S58	576	63	131.8	200	75			4.4	810	
	790	58	147.9		84.2					
	972	50	165.5		80					
300S58A	529	53	100.5	160	76	4.4	810			
	720	49	118.0		82.5					
	893	42	130.9		78					



S XING

DAN JI SHUANG XI QING SHUI LI XIN BENG

性能表

型号	流量 Q (m ³ /h)	扬程 H (m)	转速 n (r/min)	功率p (kw)		效率 η (%)	汽蚀余量 (NPSH) r (m)	重量 (kg)
				轴功率	电机功率			
300S58B	504	46	1450	87	132	73	4.4	810
	684	43		100		80		
	835	37		108		78		
300S32	612	36		75	90	80	4.6	710
	790	32		79		86.8		
	900	28		86		80		
300S32A	551	31		58.1	75	80	5.2	488
	720	26		60.7		84		
	810	24		67.9		78		
300S19	612	22		45.9	55	80	5.5	667
	790	19		47.1		86.8		
	935	16		47.9		85		
300S19A	504	20		38.7	45	71	5.5	667
	720	16		39.2		80		
	829	13		39.1		75		
300S12	612	14		29.2	37	80	5.4	1580
	790	12		30.4		84.8		
	900	10		33.1		74		
300S12A	522	11		21.7	30	72	5.8	1200
	684	10		23.9		78.4		
	792	8		22.7		76		
350S125	850	140		463	680	70	6.3	1105
	1260	125		533		80.5		
	1660	100		628		72		
350S125A	803	125		391	570	70	6.7	875
	1181	112		461		78.2		
	1570	90		550		70		
350S125B	745	108		313	500	70	7.1	760
	1098	96		373		77		
	1458	77		425		72		
350S75	972	80	271	360	78.5	7.1	760	
	1260	75	303		85.2			
	1440	65	319		80			
350S75A	900	70	220	280	78	6.3	1105	
	1170	65	244.4		84.2			
	1332	56	257		79			
350S75B	828	59	177.4	220	75	6.7	875	
	1080	55	196.3		82.4			
	1224	47	203.5		77			
350S44	927	50	163.4	220	81	7.1	760	
	1260	44	172.5		87.5			
	1476	37	188.3		79			
350S44A	864	41	121	160	80	7.1	760	
	1116	36	129.5		84.5			
	1332	30	136		80			
350S26	972	30	99	132	80	6.2	1950	
	1260	26	102		87.5			
	1440	22	105		82			
350S26A	864	26	76.5	90	80	7.1	760	
	1116	21	76.9		83.4			
	1296	16	77.4		73			
350S16	972	20	63.8	75	83	5.1	1940	
	1260	16	64.4		85.4			
	1440	13	68.9		74			
350S16A	864	16	51	55	74	5.1	1940	
	1044	13	47		78.3			
	1260	10	49		70			
400S90	1350	96	458.2	560	78	6.2	1950	
	1620	90	473		84			
	1800	85	508		82			
400S90A	1215	78	327	450	79	6.2	1950	
	1460	73	345		84			
	1621	69	371.3		82			
400S90B	1084	62	223	315	82	5.1	1940	
	1300	58	245		84			
	1445	55	264		82			
400S40	900	42	129	185	80	5.1	1940	
	1080	40	140		85			
	1260	37	150		84			
400S40A	815	35	95.8	160	81	5.1	1940	
	1007	33	107		84.5			
	1084	31	109		84			
400S40B	725	28	67.4	110	82	5.1	1940	
	870	26	73.3		84			
	967	24.7	78.4		83			

上海民泉泵业有限公司

性能表

型号	流量 Q (m ³ /h)	扬程 H (m)	转速 n (r/min)	功率p (kw)		效率 η (%)	汽蚀余量 (NPSH) r (m)	重量 (kg)							
				轴功率	电机功率										
500S98	1620	114	970	664.8	800	78	4.1	2400							
	2020	98		678.1		79.5									
	2340	79		680.3		74									
500S98A	1500	96		509	630	77									
	1872	83		539		78.5									
	2170	67		542		73									
500S98B	1400	86		431.4	560	76									
	1746	74		450.1		78.7									
	2020	59		432.8		75									
500S59	1620	67		374	450	79			4.5	2235					
	2020	59		388.2		83.6									
	2340	47		374		80									
500S59A	1500	57		315	400	74									
	1872	49		332.3		75.6									
	2170	39		320		72									
500S59B	1400	46		240	315	73									
	1746	40		255.8		74									
	2020	32		248		71									
500S35	1620	40		207.6	280	85					4.8	1640			
	2020	35		218.2		88.2									
	2340	28		209.9		85									
500S35A	1400	31		144	220	82									
	1746	27		150.6		85.2									
	2020	21		138		84									
500S22	1620	24		137.5	185	77							5.2	1555	
	2020	22		143.6		84.2									
	2340	19		142.4		85									
500S22A	1400	20		103	132	74									
	1746	17		100.6		80.3									
	2020	14		94		82									
500S13	1620	15	83.8	110	79	5.7	1505								
	2020	13	85.7		83.4										
	2340	10	79.7		80										
600S22	2520	25	209.2	250	82			7							2500
	3170	22	215.8		88										
	3600	18	215.2		82										
600S22A	2160	21	152.5	185	81										
	2860	18	161.1		87										
	3240	16	168.1		84										
600S32	2160	36	278.6	355	76										
	3170	32	310.4		89										
	3600	27	311.4		85										
600S32A	1800	30	204	280	72										
	2850	26	229		88										
	3240	23	236		86										
600S47	2160	56	412	560	80				6.5	3850					
	3170	47	456		89										
	3600	40	456		86										
600S47A	1980	46	318	450	78										
	2920	40	361		88										
	3240	37	380		86										
600S75	2160	84	568	900	87						6	4300			
	3170	75	736		88										
	3600	67	821		80										
600S75A	1980	74	486.6	710	82										
	2950	65	600.2		87										
	3240	60	661.8		80										
600S75B	1800	60	367.6	560	80										
	2710	55	477.5		85										
	3060	51	531.3		80										
600S100	2160	110	829.6	1250	78	7	4500								
	3170	100	1015.6		85										
	3600	92	1073.8		84										
600S100A	1980	100	697.3	1120	78										
	3000	90	875.4		84										
	3240	85	914.6		82										
600S100B	1800	90	588.2	900	75										
	2830	80	751.9		82										
	3060	75	781.3		80										
800S22	4320	25	358.7	730	450			7					4500		
	5500	22	370.2		89										
	6480	19	389.9		86										
	3000	16	163.4		80										
	4400	14	190.6	585	250			5							
	5040	12	193.8		88										
					85										

性能表

型号	流量 Q (m ³ /h)	扬程 H (m)	转速 n (r/min)	功率p (kw)		效率 η (%)	汽蚀余量 (NPSH) r (m)	重量 (kg)
				轴功率	电机功率			
800S22A	3960	19	730	246.9	315	83	7	4500
	4830	17		254.1		88		
	5500	15		261.2		86		
800S32	2800	13	585	123.9	185	80	5	
	3870	11		133.3		87		
	4500	9		131.3		84		
800S32A	4320	35	730	502.2	630	82	7	5100
	5500	32		538.5		89		
	6480	29		588.2		87		
800S32A	3000	23	585	234.9	315	80	4.5	
	4400	20		272.3		88		
	5200	18		299.9		85		
800S32A	3500	30	730	353	450	81	7	
	4950	26		389		88		
	6000	23		437		86		
800S32A	2700	19	585	174.6	250	80	4.5	
	3960	17		210.7		87		
	4680	14		212.4		84		
800S47	4320	51	730	740.7	1000	81	6.5	7300
	5500	47		782.2		90		
	6480	42		842.2		88		
800S47	3000	35	585	357.4	450	80	4.2	
	4400	30		403.9		89		
	5200	26		428.1		86		
800S47A	3500	45	730	530	710	81	6.5	
	5070	40		621		89		
	6000	36		684		86		
800S47A	2800	30	585	285.9	355	80	4.2	
	4060	25		314.1		88		
	4800	22		334.4		86		
800S76	4000	80	730	1103.1	1600	79	6	7888
	5500	76		1293.6		88		
	6500	71		1444.6		87		
800S76	3000	54	585	551.5	800	80	4.2	
	4400	49		674.9		87		
	5500	43		757.7		85		
800S76A	3500	70	730	845	1250	79	6	7815
	5080	65		1034		87		
	6000	62		1206		84		
800S76A	2800	48	585	463	630	79	4.2	
	4070	42		541		86		
	5000	37		607		83		
800S76B	3000	60	730	628.6	1000	78	6	7762
	4680	55		824.7		85		
	5500	51		920.3		83		
800S76B	2500	40	585	358.3	500	76	4	
	3750	35		425.5		84		
	4500	30		459.6		80		

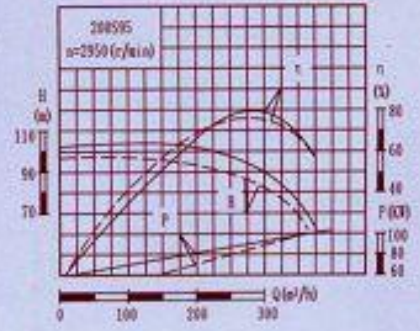
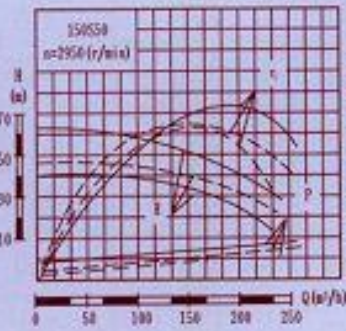
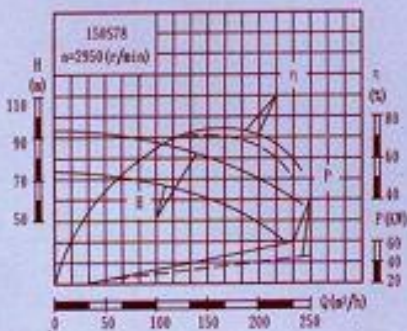
性能曲线图

性能曲线图

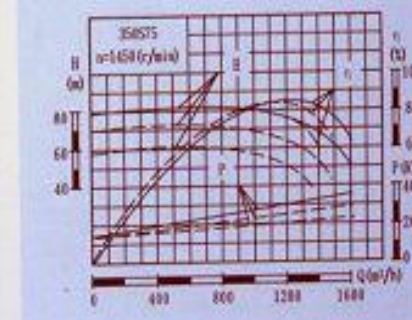
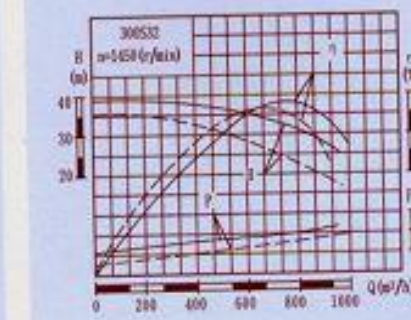
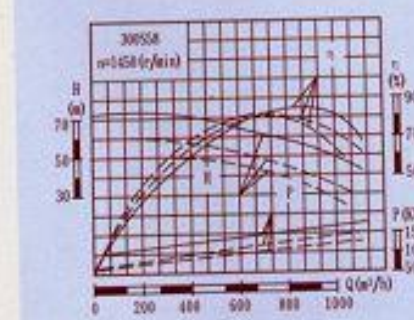
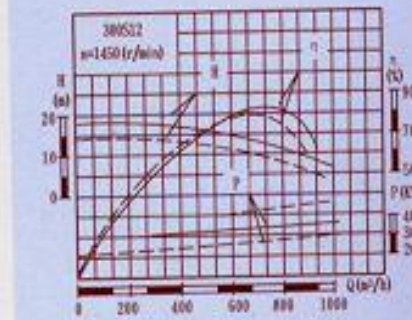
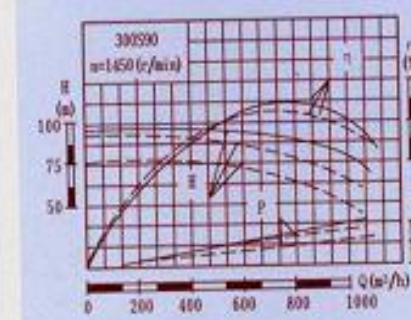
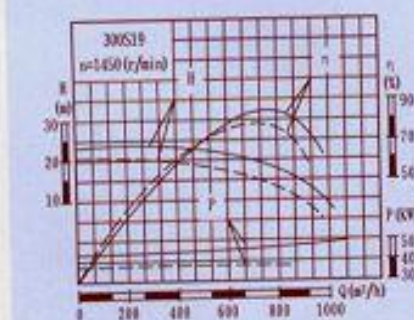
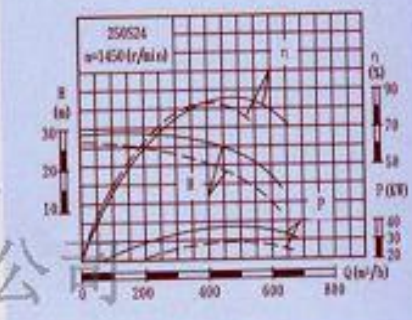
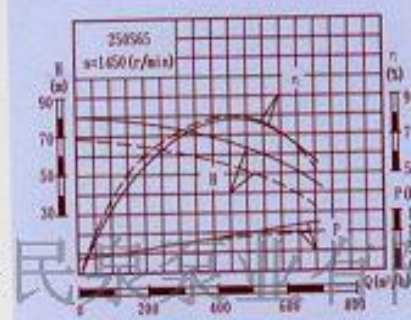
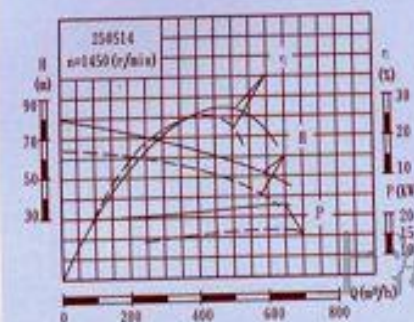
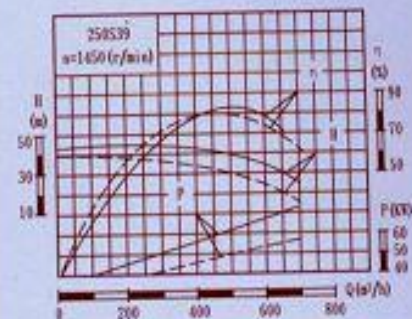
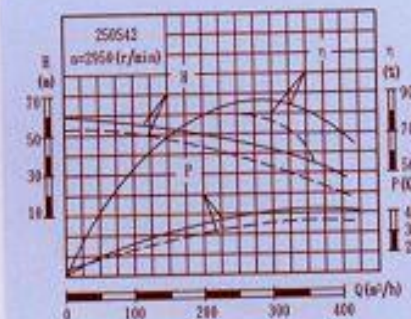
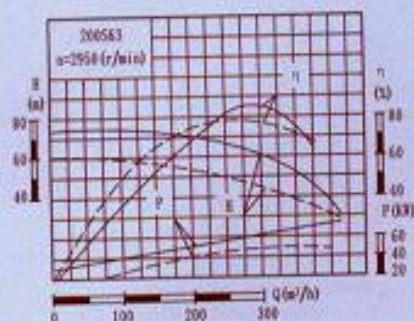

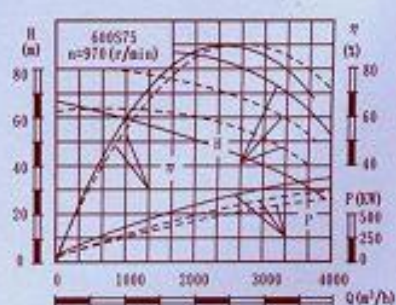
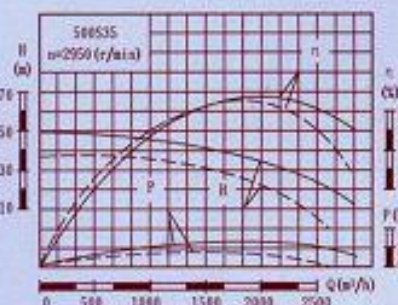
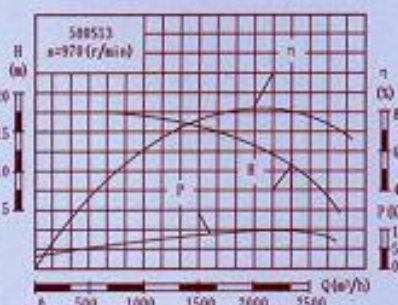
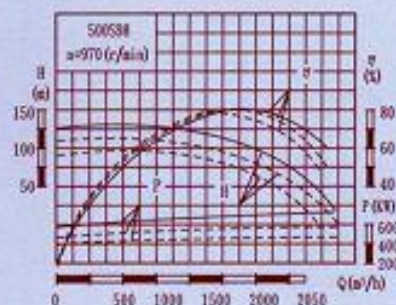
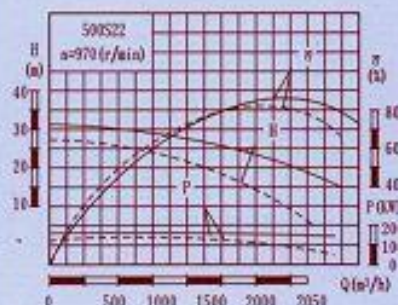
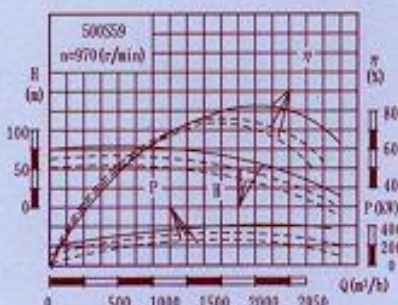
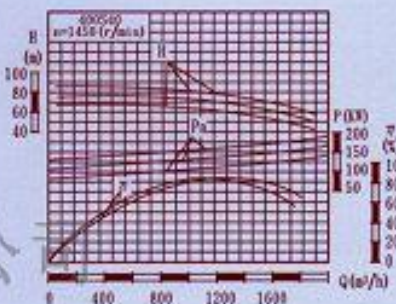
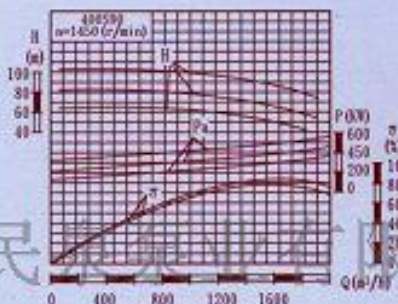
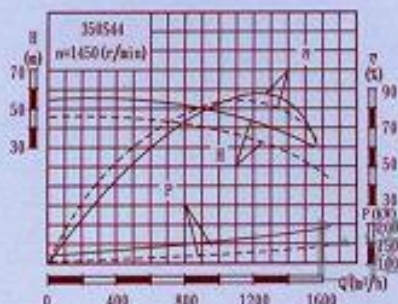
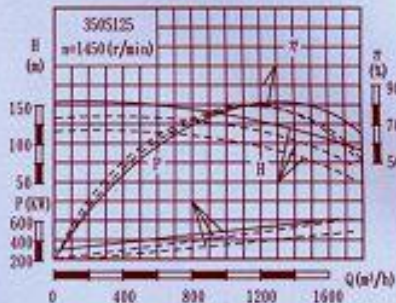
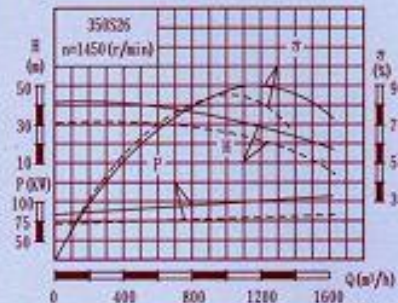
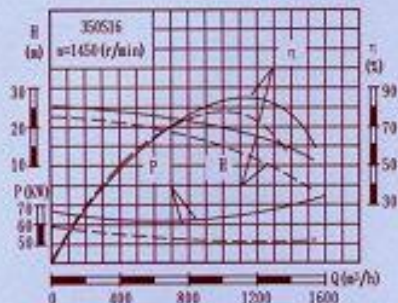
性能曲线图

性能曲线图

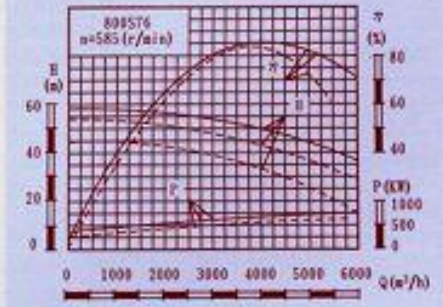
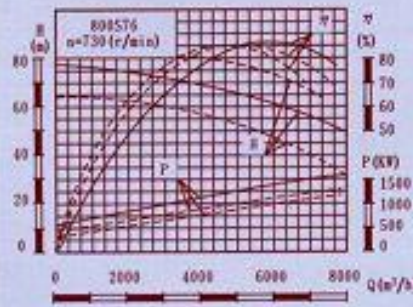
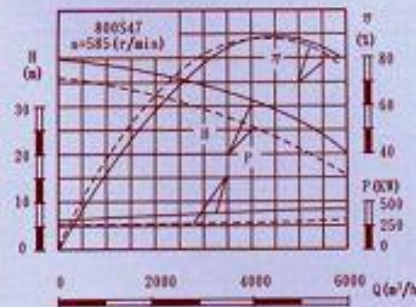
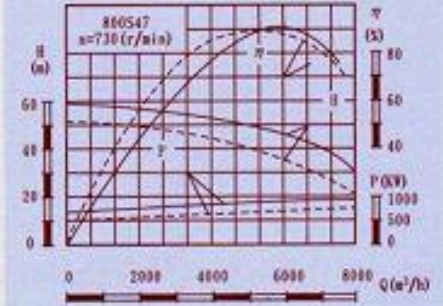
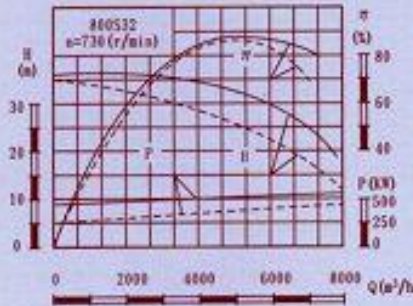
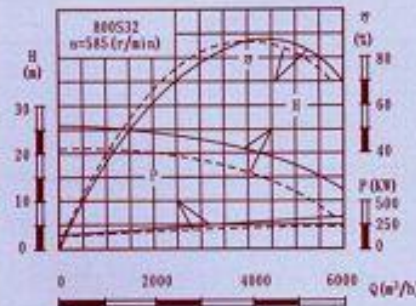
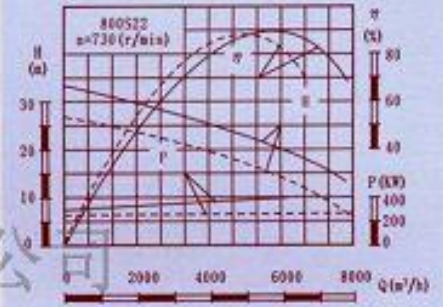
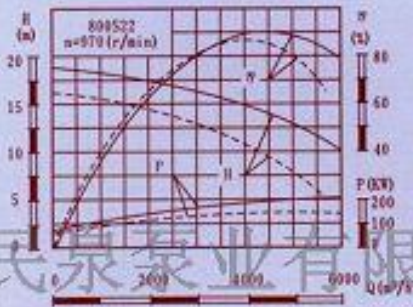
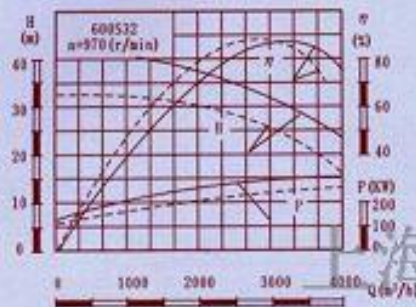
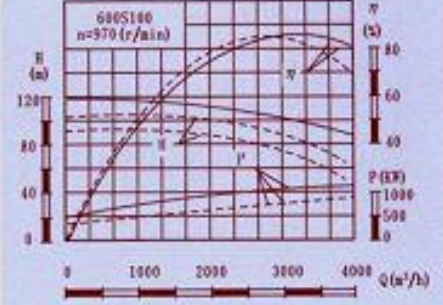
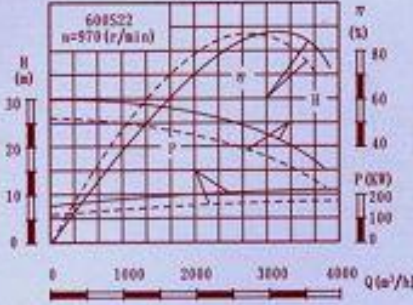
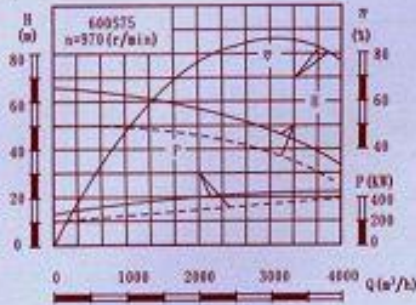



S XING

DAN JI SHUANG XI QING SHUI LI XIN BENG

外形安装图(带底座)

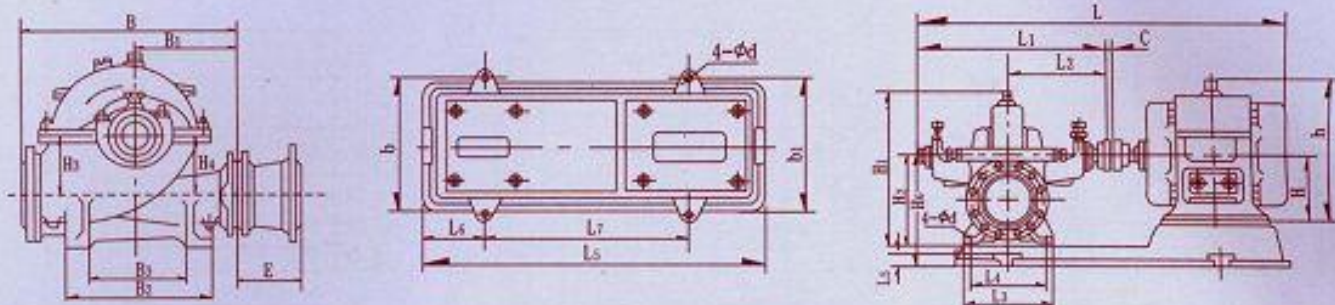

外形安装尺寸表(带底座)

泵型号	电动机		泵外形尺寸													电动机尺寸		底座尺寸						H ₆	L	E		
	型号	功率 (KW)	电压 (V)	L ₁	L ₂	L ₃	L ₄	B	B ₁	B ₂	B ₃	H ₁	H ₂	H ₃	H ₄	d ₄	h	H	L ₅	L ₆	L ₇	b	b ₁				H ₅	d
150S-78	Y250M-2	55		710	398	300	250	550	250	340	250	465	285	140	155	18	575	250	1305	173	875	430	585	40	25	385	1644	300
150S-78A	Y225M-2	45		710	398	300	250	550	250	340	250	465	285	140	155	18	530	225	1260	173	820	430	540	40	25	385	1529	300
150S-50	Y200L2-2	37		710	398	300	250	550	250	340	250	450	285	140	140	18	475	200	1182	173	800	430	500	40	25	385	1489	300
150S-50A	Y200L1-2	30		710	398	300	250	550	250	340	250	450	285	140	140	18	475	200	1182	173	800	430	500	40	25	385	1489	300
150S-50B	Y180M-2	22		710	398	300	250	550	250	340	250	450	285	140	140	18	430	180	1182	173	800	430	500	40	25	385	1384	300
200S-63	Y280S-2	75		740	410	300	250	620	300	340	250	543	355	170	170	18	640	280	1398	173	930	430	655	40	25	455	1744	220
200S-63A	Y250M-2	55		740	410	300	250	620	300	340	250	543	355	170	170	18	575	250	1335	173	900	430	600	40	25	455	1674	220
200S-42	Y225M-2	45		740	410	300	250	620	300	340	250	543	355	170	170	18	530	225	1271	198	827	465	564	45	25	455	1559	220
200S-42A	Y200L2-2	37		740	410	300	250	620	300	340	250	543	355	170	170	18	475	200	1249	198	808	465	564	45	25	455	1519	200
250S-39	Y280S-4	75		979	552	410	350	890	440	510	400	745	450	200	260	26	640	280	1665	258	1072	655	735	50	23	640	1983	300
250S-39A	Y250M-4	55		979	552	410	350	890	440	510	400	745	450	200	260	26	575	250	1586	257	1005	665	665	50	23	640	1913	300
250S-24	Y225M-4	45	380	939	522	410	350	850	400	510	400	726	450	230	230	27	530	225	1477	241	950	625	625	40	23	640	1788	300
250S-24A	Y225S-4	37		939	522	410	350	850	400	510	400	726	450	230	230	27	530	225	1477	241	950	625	625	40	23	640	1788	300
250S-14	Y200L-4	30		888	485	410	350	745	330	510	400	709	450	210	215	26	475	200	1396	241	880	625	560	40	23	625	1667	300
250S-14A	Y180M-4	18.5		888	485	410	350	745	330	510	400	709	450	210	215	26	430	180	1320	241	840	625	525	40	23	625	1562	300
300S-32	Y280S-4	90		1090	604	520	450	880	410	600	450	824	510	260	270	27	640	280	1737	283	1118	690	690	50	30	730	2153	
300S-32A	Y280S-4	75		1090	604	520	450	880	410	600	450	824	510	260	270	27	640	280	1737	283	1118	690	690	50	30	730	2153	
300S-19	Y250M-4	55		974	537	520	450	900	400	600	450	815	510	250	260	26	575	250	1632	305	1024	775	700	50	30	630	1912	
300S-19A	Y225M-4	45		974	537	520	450	900	400	600	450	815	510	250	260	26	530	225	1565	305	1000	770	685	50	30	630	1802	
300S-12	Y225S-4	37		1004	552	520	450	1000	500	600	450	820	510	265	265	26	530	225	1565	305	1000	770	685	50	30	630	1832	
300S-12A	Y200L-4	30		1004	552	520	450	1000	500	600	450	820	510	265	265	26	475	200	1527	305	951	770	605	50	30	630	1787	

DAN JI SHUANG XI QING SHUI LI XIN BENG

外形安装图(不带底座)

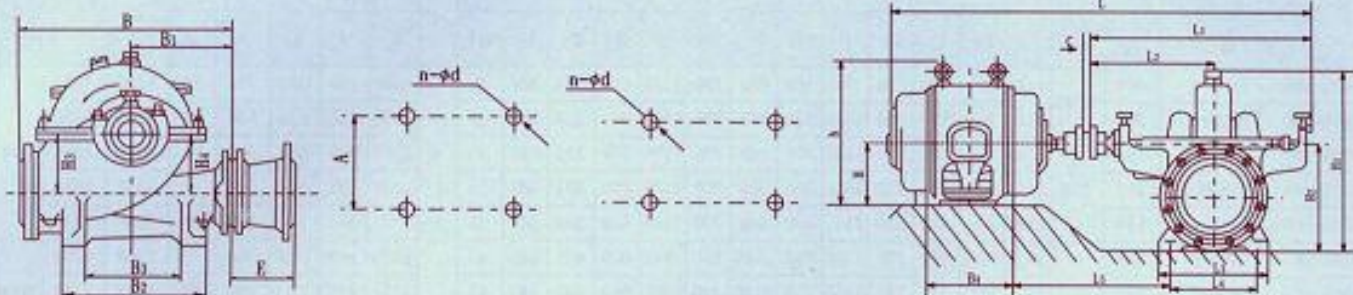

外形安装尺寸表(不带底座)

泵型号	电动机			泵外形尺寸													电动机尺寸					L5	L	E	
	型号	功率 (KW)	电压 (V)	L1	L2	L3	L4	B	B1	B2	B3	H1	H2	H3	H4	d4	C	h	H	B4	A				d
200S-95	Y315M-2	132	380	851	475	300	250	650	300	340	250	565	355	170	170	18	5	865	315	457	508	28	711	2193	500
200S-95A	Y315S-2	110		851	475	300	250	650	300	340	250	565	355	170	170	18		865	315	406	508	28	711	2123	
200S-95B	Y280M-2	90		851	475	300	250	650	300	340	250	565	355	170	170	18		640	280	419	457	24	685	1933	
250S-65	Y315L1-4	160		1047	581	410	350	880	400	570	400	783	450	240	290	26		865	315	508	508	28	797	2413	
250S-65A	Y315M-4	132		1047	581	410	350	880	400	570	400	783	450	240	290	26		865	315	457	508	28	797	2413	
250S-65B	Y280M-4	90		1047	581	410	350	880	400	570	400	783	450	240	290	26		640	280	419	457	24	741	2123	
300S-90	Y355-4	315	6000	1169	644	520	450	1046	470	600	450	898	510	268	325	28	1065	355	900	630	28	949	2914		
300S-90A	Y355-4	280		1169	644	520	450	1046	470	600	450	898	510	268	325	28	1065	355	900	630	28	949	2914		
300S-90B	Y355-4	220		1169	644	520	450	1046	470	600	450	898	510	268	325	28	1065	355	900	630	28	949	2914		
300S-58	Y315L2-4	200	380	1139	630	510	450	1070	530	620	550	852	510	240	310	26	865	315	508	508	28	797	2485		
300S-58A	Y315L1-4	160		1139	630	510	450	1070	530	620	550	852	510	240	310	26	865	315	508	508	28	797	2485		
300S-58B	Y315M-4	132		1139	630	510	450	1070	530	620	550	852	510	240	310	26	865	315	457	508	28	797	2485		
350S-125	Y450-4	710	6000	1431	809	600	500	1210	550	690	550	1082	620	330	410	35	6	1350	450	1120	800	35	1131	3560	
350S-125A	Y450-4	630		1431	809	600	500	1210	550	690	550	1082	620	330	410	35		1350	450	1120	800	35	1131	3560	
350S-125B	Y400-4	500		1431	809	600	500	1210	550	690	550	1082	620	330	410	35		1200	400	1000	710	35	1131	3330	
350S-75	Y400-4	355		1243	680	600	500	1250	600	690	500	1004	620	274	356	23		1200	400	1000	710	35	1001	3169	
350S-75A	Y355-4	280		1243	680	600	500	1250	600	690	500	1004	620	274	356	23		1065	355	900	630	28	961	2989	
350S-75B	Y355-4	250		1243	680	600	500	1250	600	690	500	1004	620	274	356	23		1065	355	900	630	28	961	2989	
350S-44	Y355M-4	220	380	1233	675	600	500	1080	510	690	500	980	620	300	300	35	1010	355	560	610	28	854	2547		
350S-44A	Y355L1-4	160		1233	675	600	500	1080	510	690	500	980	620	300	300	35	865	315	508	508	28	817	2609		
350S-26	Y315M-4	132		1173	642	580	500	1040	460	680	600	963	620	290	300	35	865	315	457	508	28	784	2519		
350S-26A	Y315S-4	110		1173	642	580	500	1040	460	680	600	963	620	290	300	35	865	315	406	508	28	793	2448		
350S-16	Y280S-4	75		1130	624	600	500	1168	584	690	500	979	620	310	310	34	640	280	468	457	24	708	2134		
350S-16A	Y250M-4	55		1130	624	600	500	1168	584	690	500	979	620	310	310	34	575	250	349	406	24	686	2064		
400S-90	Y400-4	560	6000	1440	805	820	700	1545	800	900	700	1130	670	334	382	35	6	1200	400	1000	710	35	1128	3673	



S XING

DAN JI SHUANG XI QING SHUI LI XIN BENG

外形安装尺寸表(不带底座)

泵型号	电动机		泵外形尺寸													电动机尺寸					L ₅	L	E		
	型号	功率(kW)	电压(V)	L ₁	L ₂	L ₃	L ₄	B	B ₁	B ₂	B ₃	H ₁	H ₂	H ₃	H ₃	d ₄	C	b	H	B ₄				A	d
400S-90A	Y400-4	450	6000	1440	805	820	700	1545	800	900	700	1130	670	334	382	35	6	1200	400	1000	710	35	1128	3673	500
400S-90B	Y355-4	315		1440	805	820	700	1545	800	900	700	1130	670	334	382	35		1065	355	900	630	28	1088	3493	
400S-40	Y355M-6	185	380	1440	805	820	700	1545	800	900	700	1130	670	334	382	35	1010	355	560	610	28	1027	3031		
400S-40A	Y355M-6	160		1440	805	820	700	1545	800	900	700	1130	670	334	382	35	1010	355	560	610	28	1027	3031		
400S-40B	Y315L-6	110		1440	805	820	700	1545	800	900	700	1130	670	334	382	35		865	315	508	508	28	949	3093	
500S-98	Y500-6	800	6000	1905	1025	910	780	1550	750	1100	800	1641	900	425	545	42	6	1500	500	1250	900	42	1368	4233	1000
500S-98A	Y450-6	630		1905	1025	910	780	1550	750	1100	800	1641	900	425	545	42		1350	450	1120	800	35	1248	4103	
500S-98B	Y450-6	560	1905	1025	910	780	1550	750	1100	800	1641	900	425	545	42	1350	450	1120	800	35	1248	4103			
500S-59	Y450-6	450	380	1900	1022	910	780	1550	750	1100	800	1604	900	425	500	42	6	1350	450	1120	800	35	1245	4008	800
500S-59A	Y400-6	400		1900	1022	910	780	1550	750	1100	800	1604	900	425	500	42		1200	400	1000	710	35	1205	3828	
500S-59B	Y400-6	315	1900	1022	910	780	1550	750	1100	800	1604	900	425	500	42	1200	400	1000	710	35	1205	3828			
500S-35	Y400-6	280		1374	766	760	580	1350	630	1020	800	1270	800	415	415	42		1200	400	1000	710	35	1049	3578	
500S-35A	Y355-6	220	380	1374	766	760	580	1350	630	1020	800	1270	800	415	415	42	6	1065	355	900	630	28	1009	3398	600
500S-22	Y355M-6	185		1630	890	740	600	1380	650	920	720	1400	800	430	455	42		1010	355	560	610	28	1062	2916	
500S-22A	Y315L-6	132	1630	890	740	600	1380	650	920	720	1400	800	430	455	42	865	315	508	508	28	984	2978			
500S-13	Y315L-6	110		1460	790	740	600	1380	650	920	720	1431	800	400	400	42	8	865	315	508	508	28	884	2808	
600S-100	Y560-6	1250	6000	1900	1060	940	760	2100	900	1020	800	1600	950	490	590	42	6	1700	560	1400	1000	42	1488	4808	800
600S-100A	Y560-6	1120		1900	1060	940	760	2100	900	1020	800	1600	950	490	590	42		1700	560	1400	1000	42	1488	4808	
600S-100B	Y500-6	900	1900	1060	940	760	2100	900	1020	800	1600	950	490	590	42	1900	500	1250	900	42	1413	4228			
600S-75	Y500-6	900	380	2029	1085	1100	900	1800	800	1000	1000	1706	950	532	663	42	6	1900	500	1250	900	42	1368	4357	600
600S-75A	Y500-6	710		2029	1085	1100	900	1800	800	1000	1000	1706	950	532	663	42		1900	500	1250	900	42	1368	4357	
600S-75B	Y450-6	560		2029	1085	1100	900	1800	800	1000	1000	1706	950	532	663	42		1350	450	1120	800	35	1248	4140	
600S-47	Y450-6	560	380	1942	1085	1100	900	1800	800	1300	1000	1700	950	532	663	42	6	1350	450	1120	800	35	1248	4140	
600S-47A	Y450-6	450		1942	1085	1100	900	1800	800	1300	1000	1700	950	532	663	42		1350	450	1120	800	35	1248	4140	
600S-32	Y400-6	355	380	1791	955	940	760	1590	750	1240	1000	1710	900	500	530	42	6	1200	400	1000	710	35	1148	3718	600
600S-32A	Y400-6	280		1791	955	940	760	1590	750	1240	1000	1710	900	500	530	42		1200	400	1000	710	35	1148	3718	
600S-22	Y355-6	250		1472	810	940	760	1790	840	1020	800	1490	950	460	460	42		1065	355	900	630	28	963	3220	
600S-22A	Y355M-6	185	1472	810	940	760	1790	840	1020	800	1490	950	460	460	42	1010	355	560	610	28	982	2758			
800S-76	Y630-8	1600	6000	2727	1455	1300	1000	2448	1088	1700	1350	2105	1250	730	900	56	6	1900	630	1600	1120	48	1793	5835	600
	Y560-10	800		2727	1455	1300	1000	2448	1088	1700	1350	2105	1250	730	900	56		1700	560	1400	1000	42	1763	5635	
800S-76A	Y630-8	1250		2727	1455	1300	1000	2448	1088	1700	1350	2105	1250	730	900	56		1900	630	1600	1120	48	1793	5035	
	Y500-10	630	2727	1455	1300	1000	2448	1088	1700	1350	2105	1250	730	900	56	1500	500	1250	900	42	1688	5055			
800S-76B	Y560-8	1000	380	2727	1455	1300	1000	2448	1088	1700	1350	2105	1250	730	900	56	6	1700	560	1400	1000	42	1763	5635	600
	Y500-10	500		2727	1455	1300	1000	2448	1088	1700	1350	2105	1250	730	900	56		1500	500	1250	900	42	1688	5055	
800S-47	Y560-8	1000	6000	2750	1510	1300	1000	2280	1000	1700	1350	2105	1250	700	850	48	6	1700	560	1400	1000	42	1818	5658	
	Y500-10	450		2750	1510	1300	1000	2280	1000	1700	1350	2105	1250	700	850	48		1500	500	1250	900	42	1743	5078	
800S-47A	Y500-8	710		2750	1510	1300	1000	2280	1000	1700	1350	2105	1250	700	850	48	7	1500	500	1250	900	42	1743	5078	
	Y450-10	355	2750	1510	1300	1000	2280	1000	1700	1350	2105	1250	700	850	48	1350		450	1120	800	35	1623	4948		
800S-32	Y500-8	630	380	2120	1170	1200	1000	2250	1000	1300	1000	1920	1200	640	640	48	6	1500	500	1250	900	42	1403	4448	600
	Y450-10	315		2120	1170	1200	1000	2250	1000	1300	1000	1920	1200	640	640	48		1350	450	1120	800	35	1283	4318	
800S-32A	Y450-8	450		2120	1170	1200	1000	2250	1000	1300	1000	1920	1200	640	640	48		1350	450	1120	800	35	1283	4318	
	Y450-10	250	2120	1170	1200	1000	2250	1000	1300	1000	1920	1200	640	695	48	1350	450	1120	800	35	1283	4318			
800S-22	Y450-8	450	380	2220	1220	1200	1000	2150	750	1200	900	2210	1265	755	695	48	6	1350	450	1120	800	35	1333	4418	600
	Y450-10	250		2220	1220	1200	1000	2150	750	1200	900	2210	1265	755	695	48		1350	450	1120	800	35	1333	4418	
800S-22A	Y450-8	315		2220	1220	1200	1000	2150	750	1200	900	2210	1265	755	695	48		1350	450	1120	800	35	1333	4418	
	Y355L-10	185	2220	1220	1200	1000	2150	750	1200	900	2210	1265	755	695	48	1120	355	630	610	28	1192	3768			

泵进口及吐出锥管和出口法兰尺寸

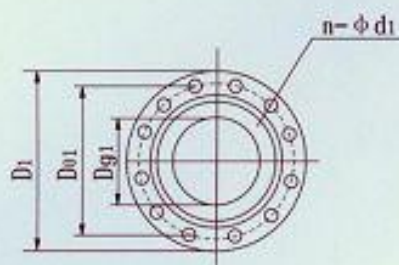

进口及吐出锥管法兰

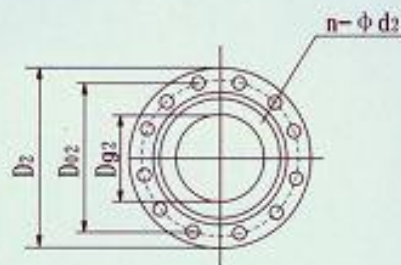

出口法兰

泵型号	进口及吐出锥管法兰				出口法兰			
	Dg1	Do1	D1	n-φd1	Dg2	Do2	D2	n-φd2
150S-78	150	240	280	8-φ23	100	180	215	8-φ18
150S-50	150	240	280	8-φ23	100	180	215	8-φ18
200S-63	200	295	335	8-φ23	150	240	280	8-φ23
200S-42	200	295	335	8-φ23	150	240	280	8-φ23
200S-95	200	295	335	8-φ23	125	210	250	8-φ18
250S-65	250	350	395	12-φ23	150	240	285	8-φ23
250S-39	250	350	395	12-φ23	200	295	340	8-φ23
250S-24	250	350	390	12-φ23	200	295	335	8-φ23
250S-14	250	350	395	12-φ23	200	295	340	8-φ23
300S-90	300	400	445	12-φ23	200	295	340	8-φ23
300S-58	300	400	440	12-φ23	250	350	390	12-φ23
300S-32	300	400	440	12-φ23	250	350	390	12-φ23
300S-19	300	400	445	12-φ23	250	350	395	12-φ23
300S-12	300	400	445	12-φ23	300	400	445	12-φ23
350S-125	350	460	505	16-φ23	250	350	395	12-φ23
350S-75	350	460	500	16-φ23	250	350	390	12-φ23
350S-44	350	460	505	16-φ23	300	400	445	12-φ23
350S-26	350	460	500	16-φ23	300	400	440	12-φ23
350S-16	350	460	505	16-φ23	350	400	505	16-φ23